

Product: PKL-KOB05 41 40-52

Product code: 88712022

Cable clamp

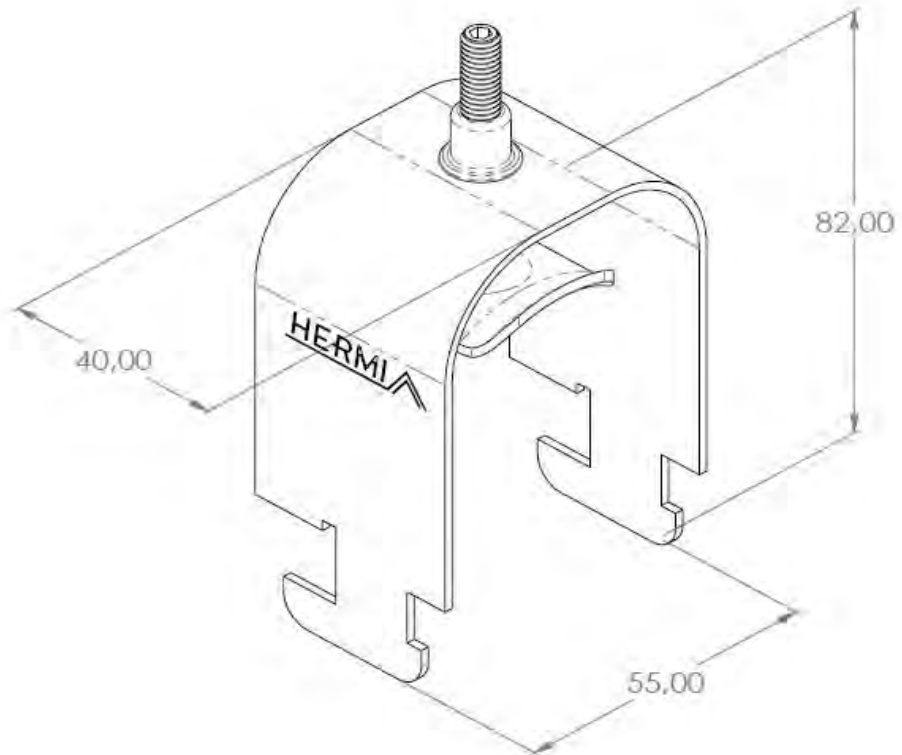

<b>Standard:</b>	EN 61537:2007 Cable management - Cable tray systems and cable ladder systems
<b>Dimensions:</b>	Length: 40 mm
	Width: Conductor width 40-52 mm
	Height: 82 mm
	Metal thickness: mm
<b>Weight:</b>	0,11 kg
<b>Material:</b>	Galvanised steel
<b>Contribution to fire:</b>	Non-flame propagating system
<b>Electrical characteristics:</b>	Electrically conductive system
<b>Electrical continuity:</b>	Yes
<b>Corrosion resistance:</b>	Class 3
<b>Temperature:</b>	Min: -20°C; Max: +105°C