

Product: PKL-KO HD 100/400/90°

Product code: 88712004

Elbow 90°

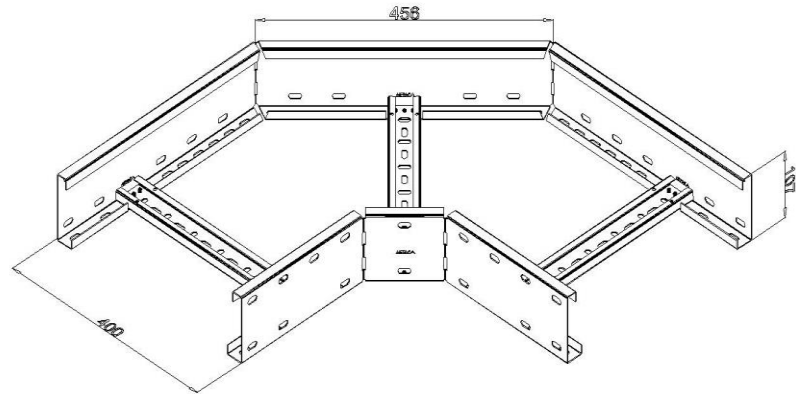

Standard:	EN 61537:2007 Cable management - Cable tray systems and cable ladder systems
Dimensions:	Length: 456 mm
	Width: 400 mm
	Height: 107 mm
	Metal thickness: 1,5 mm
Weight:	
Material:	Galvanised steel
Contribution to fire:	Non-flame propagating system
Electrical characteristics:	Electrically conductive system
Electrical continuity:	Yes
Corrosion resistance:	Class 3
Temperature:	Min: -20°C; Max: +105°C