

Product: PKL-KR 60/300

Product code: 88711653

Cross-over

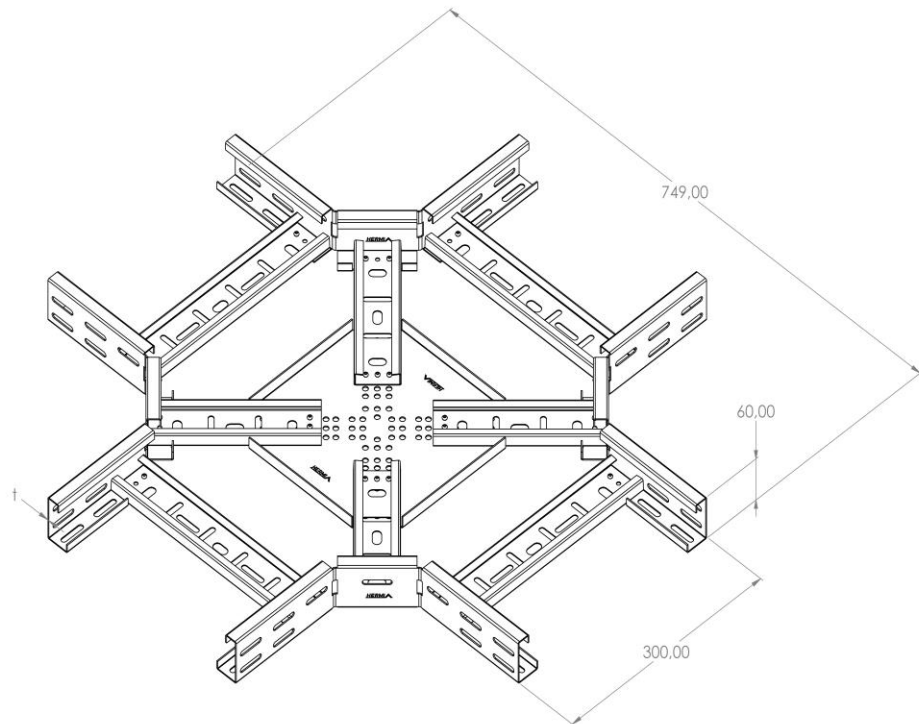

Standard:	EN 61537:2007 Cable management - Cable tray systems and cable ladder systems
Dimensions:	Length: 749 mm
	Width: 300 mm
	Height: 60 mm
	Metal thickness: 1 mm
Weight:	3,74 kg
Material:	Hot-dip galvanised steel
Contribution to fire:	Non-flame propagating system
Electrical characteristics:	Electrically conductive system
Electrical continuity:	Yes
Corrosion resistance:	Class 6
Temperature:	Min: -20°C; Max: +105°C