

Product: PKL-KO 60/600/45°

Product code: 88711136

Elbow 45°

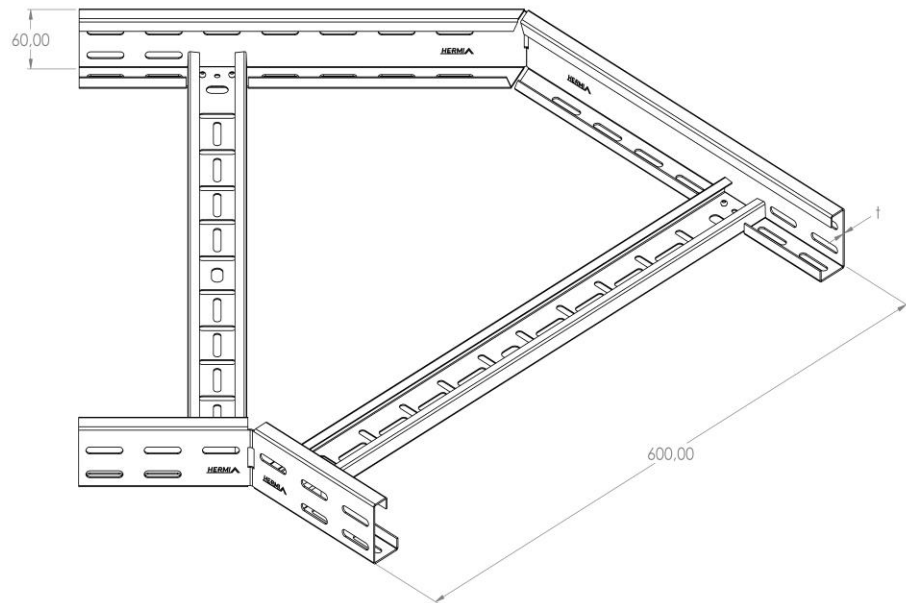

Standard:	EN 61537:2007 Cable management - Cable tray systems and cable ladder systems
Dimensions:	Length: mm
	Width: 600 mm
	Height: 60 mm
	Metal thickness: 1 mm
Weight:	2,3 kg
Material:	Galvanised steel
Contribution to fire:	Non-flame propagating system
Electrical characteristics:	Electrically conductive system
Electrical continuity:	Yes
Corrosion resistance:	Class 3
Temperature:	Min: -20°C; Max: +105°C