

**Product:** KL 60/100

**Product code:** 88710691

Cable ladders of 60 mm in height

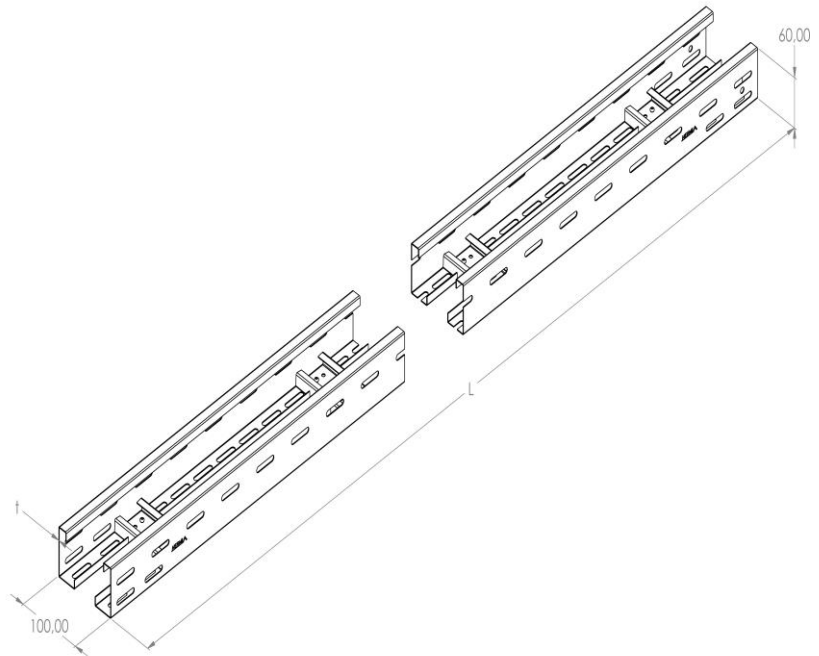

<b>Standard:</b>	EN 61537:2007 Cable management - Cable tray systems and cable ladder systems
<b>Dimensions:</b>	Length: 3000 mm
	Width: 100 mm
	Height: 60 mm
	Metal thickness: 1,5 mm
<b>Weight:</b>	9,9 kg
<b>Material:</b>	Hot-dip galvanised steel
<b>Contribution to fire:</b>	Non-flame propagating system
<b>Electrical characteristics:</b>	Electrically conductive system
<b>Electrical continuity:</b>	Yes
<b>Corrosion resistance:</b>	Class 6
<b>Perforation:</b>	Class Y
<b>Temperature:</b>	Min: -20°C; Max: +105°C

**Permissible load KL 60/100 d=1,5mm (kN/m)**

