

Product: KL 60/200

Product code: 88710182

Cable ladders of 60 mm in height

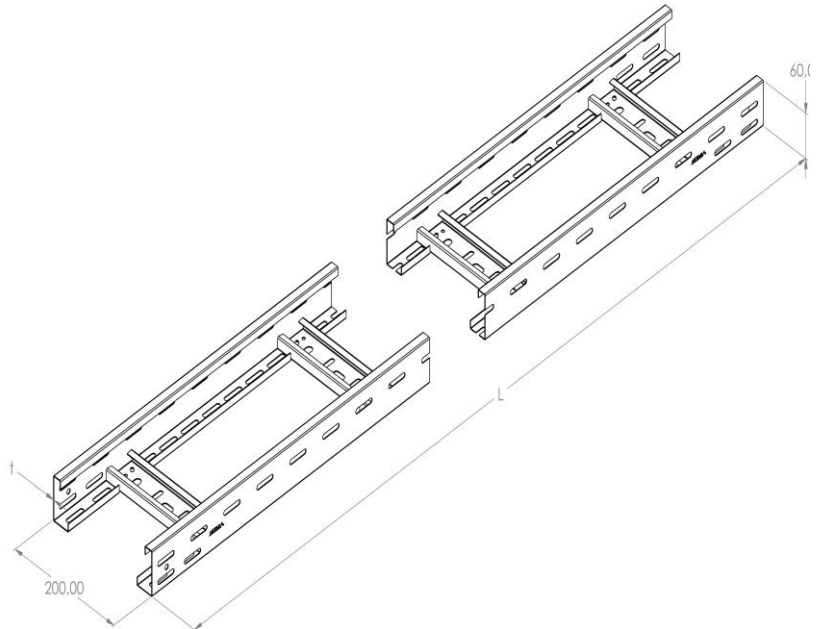

Standard:	EN 61537:2007 Cable management - Cable tray systems and cable ladder systems
Dimensions:	Length: 3000 mm
	Width: 200 mm
	Height: 60 mm
	Metal thickness: 1,5 mm
Weight:	9,8 kg
Material:	Galvanised steel
Contribution to fire:	Non-flame propagating system
Electrical characteristics:	Electrically conductive system
Electrical continuity:	Yes
Corrosion resistance:	Class 3
Perforation:	Class Y
Temperature:	Min: -20°C; Max: +105°C

Permissible load KL 60/200 d=1,5mm (kN/m)

