

Product: NKP-SNV HD 810

Product code: 88708268

Welded wall bracket

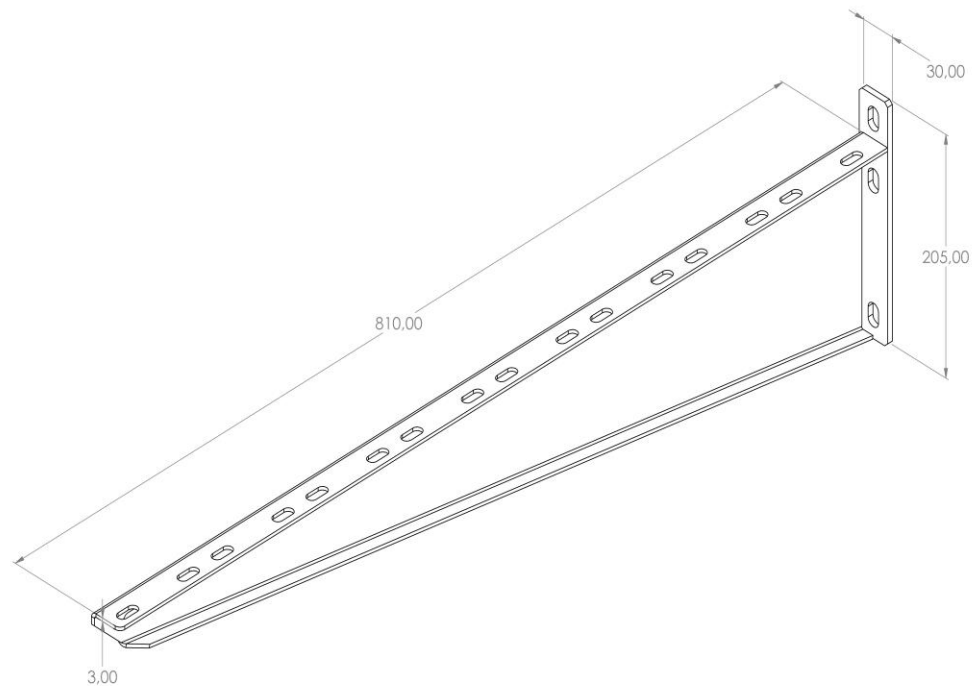

Standard:	EN 61537:2007 Cable management - Cable tray systems and cable ladder systems
Dimensions:	Length: 810 mm
	Width: 30 mm
	Height: 205 mm
	Metal thickness: 3 mm
Maximum load:	3,7 kN
Weight:	2,67 kg
Material:	Stainless steel
Contribution to fire:	Non-flame propagating system
Electrical characteristics:	Electrically conductive system
Electrical continuity:	Yes
Corrosion resistance:	Class 9A
Temperature:	Min: -20°C; Max: +105°C