

Product: NKP-SNTM 310

Product code: 88708253

Wall bracket

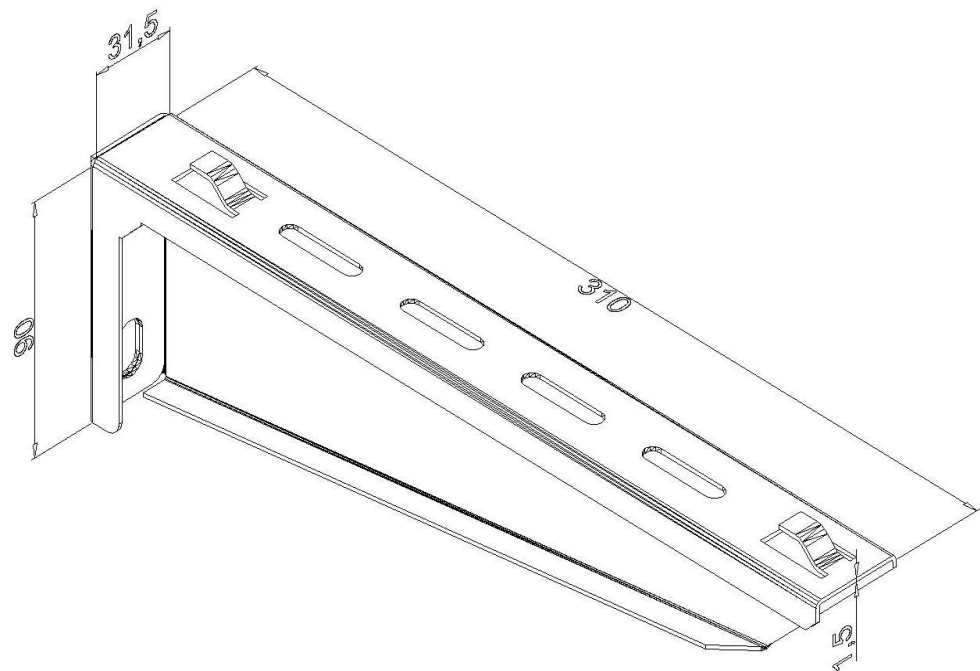

Standard:	EN 61537:2007 Cable management - Cable tray systems and cable ladder systems
Dimensions:	Length: 310 mm
	Width: 31,5 mm
	Height: 90 mm
	Metal thickness: 1,5 mm
Maximum load:	2,25 kN
Weight:	0,48 kg
Material:	Stainless steel
Contribution to fire:	Non-flame propagating system
Electrical characteristics:	Electrically conductive system
Electrical continuity:	Yes
Corrosion resistance:	Class 9A
Temperature:	Min: -20°C; Max: +105°C