

Product: NKP-DUL/P 800

Product code: 88708233

Hanging bracket

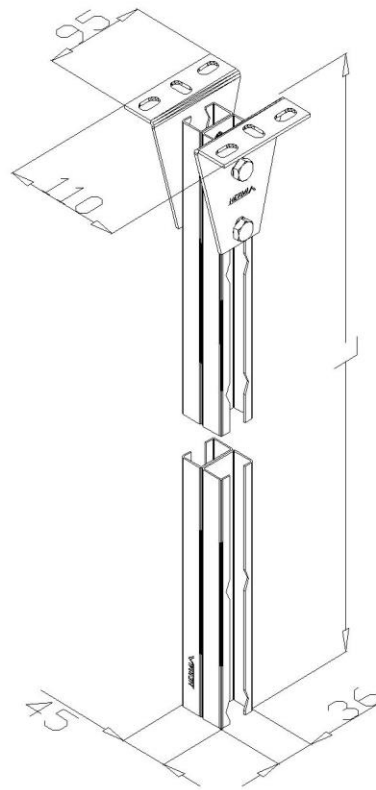

| | |
|------------------------------------|--|
| Standard: | EN 61537:2007 Cable management - Cable tray systems and cable ladder systems |
| Dimensions: | Length: 95 mm |
| | Width: 110 mm |
| | Height: 800 mm |
| | Metal thickness: 3 mm |
| Maximum bending moment: | 0,25 kNm |
| Weight: | |
| Material: | Stainless steel |
| Contribution to fire: | Non-flame propagating system |
| Electrical characteristics: | Electrically conductive system |
| Electrical continuity: | Yes |
| Corrosion resistance: | Class 9A |
| Temperature: | Min: -20°C; Max: +105°C |