

Product: NPK-WK 110

Product code: 88707301

Welded wall bracket

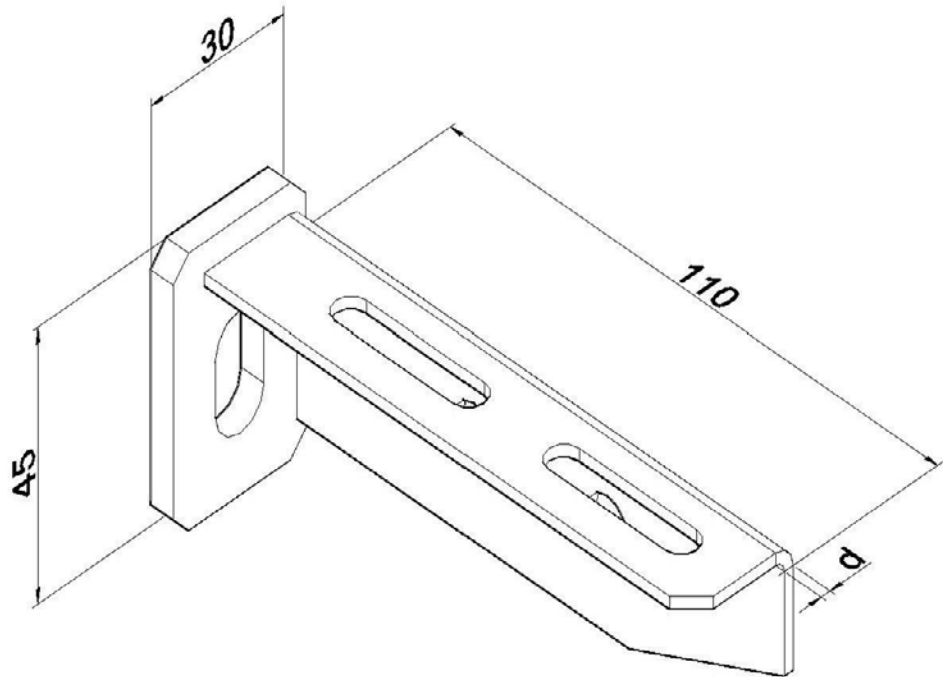

Standard:	EN 61537:2007 Cable management - Cable tray systems and cable ladder systems
Dimensions:	Length: 110 mm
	Width: 30 mm
	Height: 45 mm
	Metal thickness: 1,5 mm
Maximum load:	2,5 kN
Weight:	0,14 kg
Material:	Galvanised steel
Contribution to fire:	Non-flame propagating system
Electrical characteristics:	Electrically conductive system
Electrical continuity:	Yes
Corrosion resistance:	Class 3
Temperature:	Min: -20°C; Max: +105°C