

Product: NKP-SNL/OMEGA 310

Product code: 88707173

Wall bracket

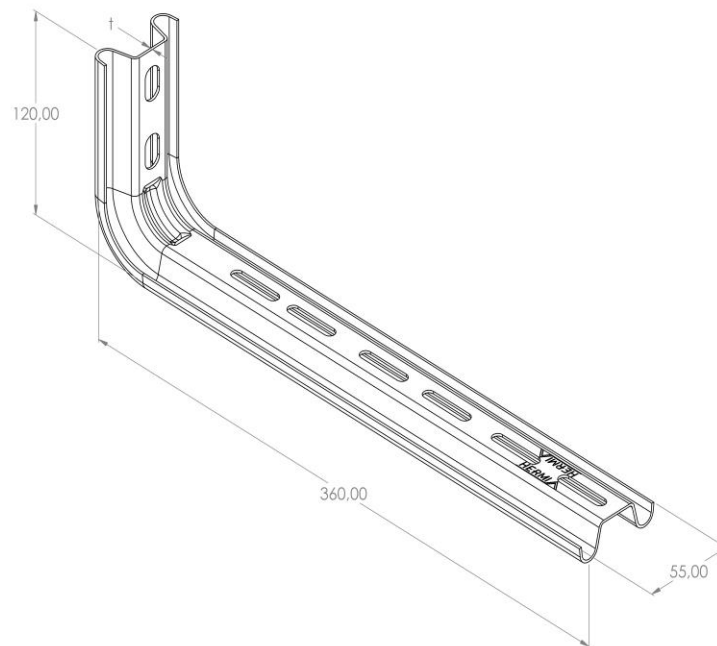

Standard:	EN 61537:2007 Cable management - Cable tray systems and cable ladder systems
Dimensions:	Length: 360 mm
	Width: 55 mm
	Height: 120 mm
	Metal thickness: 1,5 mm
Maximum load:	0,6 kN
Weight:	0,45 kg
Material:	Galvanised steel
Contribution to fire:	Non-flame propagating system
Electrical characteristics:	Electrically conductive system
Electrical continuity:	Yes
Corrosion resistance:	Class 3
Temperature:	Min: -20°C; Max: +105°C