

Product: NKP-SNV HD 910

Product code: 88707169

Welded wall bracket

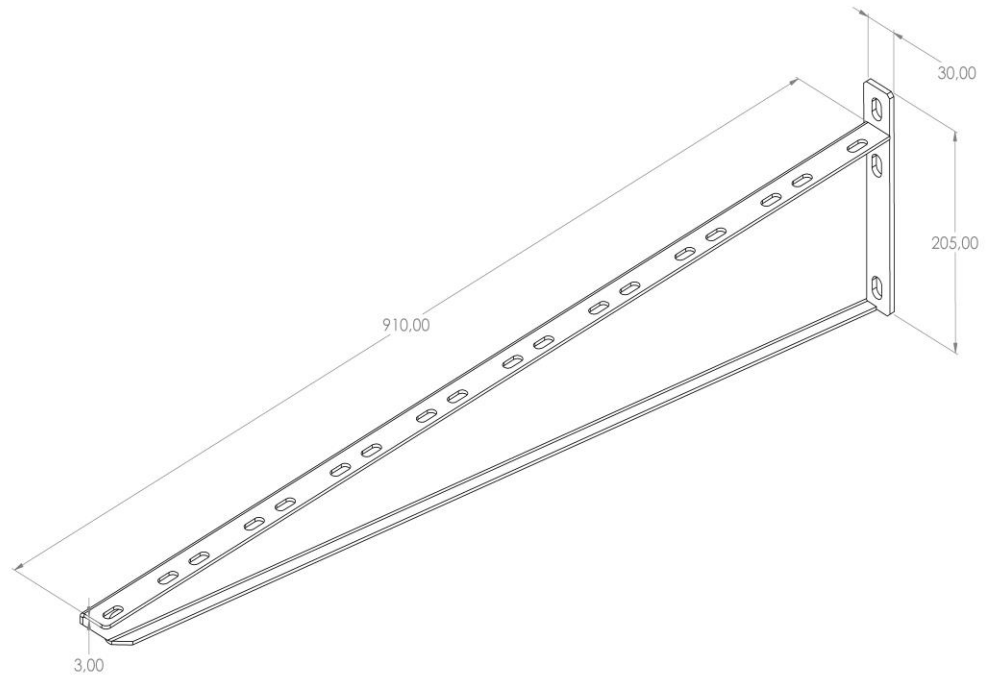

Standard:	EN 61537:2007 Cable management - Cable tray systems and cable ladder systems
Dimensions:	Length: 910 mm
	Width: 30 mm
	Height: 205 mm
	Metal thickness: 3 mm
Maximum load:	2,85 kN
Weight:	2,99 kg
Material:	Galvanised steel
Contribution to fire:	Non-flame propagating system
Electrical characteristics:	Electrically conductive system
Electrical continuity:	Yes
Corrosion resistance:	Class 3
Temperature:	Min: -20°C; Max: +105°C