

Product: NKP-SNU/P 1000

Product code: 88707103

Hanging bracket

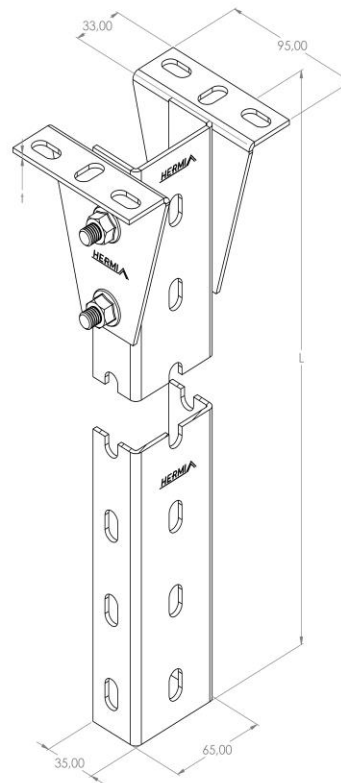

Standard:	EN 61537:2007 Cable management - Cable tray systems and cable ladder systems
Dimensions:	Length: 65 mm
	Width: 35 mm
	Height: 1000 mm
	Metal thickness: 3 mm
Maximum bending moment:	0,9 kNm
Weight:	3,26 kg
Material:	Galvanised steel
Contribution to fire:	Non-flame propagating system
Electrical characteristics:	Electrically conductive system
Electrical continuity:	Yes
Corrosion resistance:	Class 3
Temperature:	Min: -20°C; Max: +105°C