

Product: PKP-NK 100/600

Product code: 88706906

Internal elbow 90°

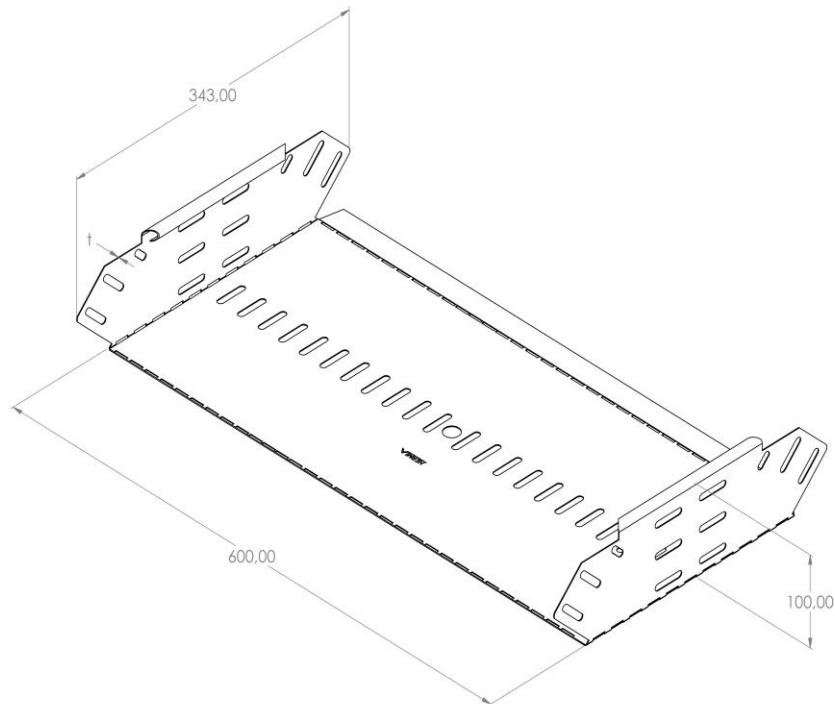

Standard:	EN 61537:2007 Cable management - Cable tray systems and cable ladder systems
Dimensions:	Length: 343 mm
	Width: 600 mm
	Height: 100 mm
	Metal thickness: 0,80 mm
Weight:	
Material:	Hot-dip galvanised steel
Contribution to fire:	Non-flame propagating system
Electrical characteristics:	Electrically conductive system
Electrical continuity:	Yes
Corrosion resistance:	Class 6
Temperature:	Min: -20°C; Max: +105°C