

Product: NPK-VNU/OMEGA 510

Product code: 88704795

Hanging bracket

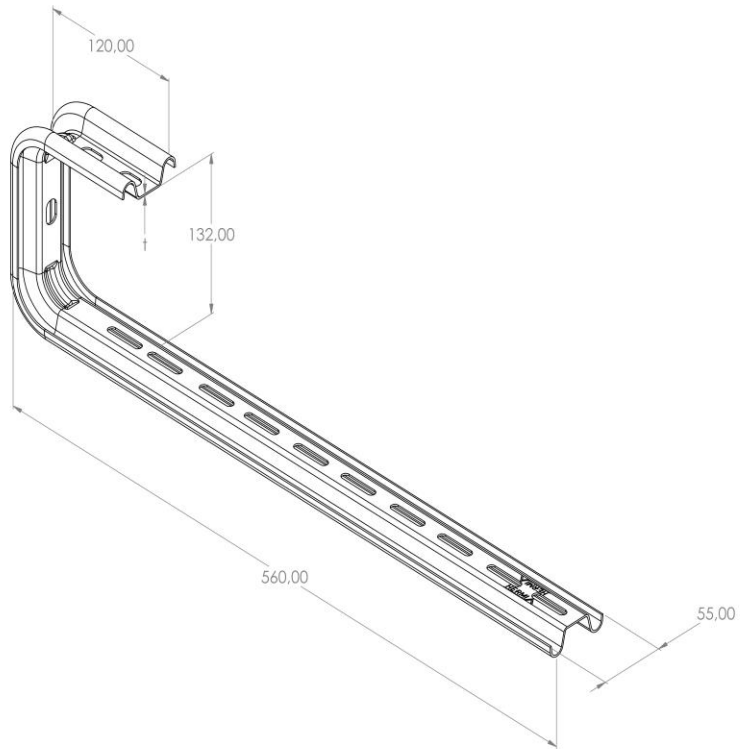

Standard:	EN 61537:2007 Cable management - Cable tray systems and cable ladder systems
Dimensions:	Length: 560 mm
	Width: 55 mm
	Height: 132 mm
	Metal thickness: 1,5 mm
Maximum load:	0,15 kN
Weight:	0,82 kg
Material:	Acid resistant stainless steel
Contribution to fire:	Non-flame propagating system
Electrical characteristics:	Electrically conductive system
Electrical continuity:	Yes
Corrosion resistance:	Class 9B
Temperature:	Min: -20°C; Max: +105°C