

Product: NKP-TN 200

Product code: 88704732

Floor bracket

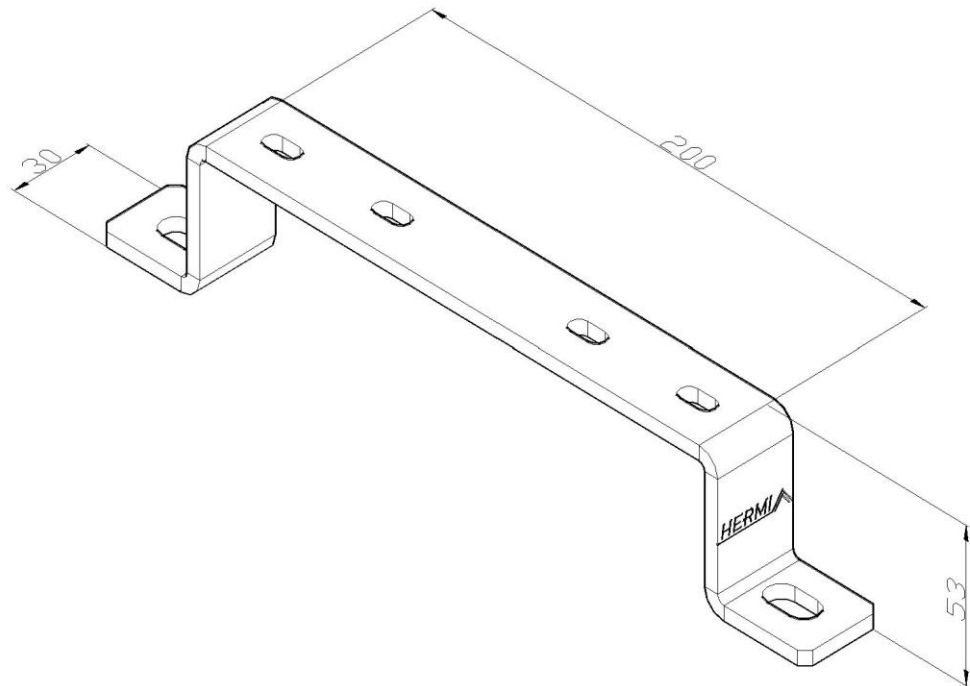

Standard:	EN 61537:2007 Cable management - Cable tray systems and cable ladder systems
Dimensions:	Length: 200 mm
	Width: 30 mm
	Height: 53 mm
	Metal thickness: 5 mm
Maximum load:	
Weight:	0,3 kg
Material:	Acid resistant stainless steel
Contribution to fire:	Non-flame propagating system
Electrical characteristics:	Electrically conductive system
Electrical continuity:	Yes
Corrosion resistance:	Class 9B
Temperature:	Min: -20°C; Max: +105°C