

Product: NKP-TN 400

Product code: 88704634

Floor bracket

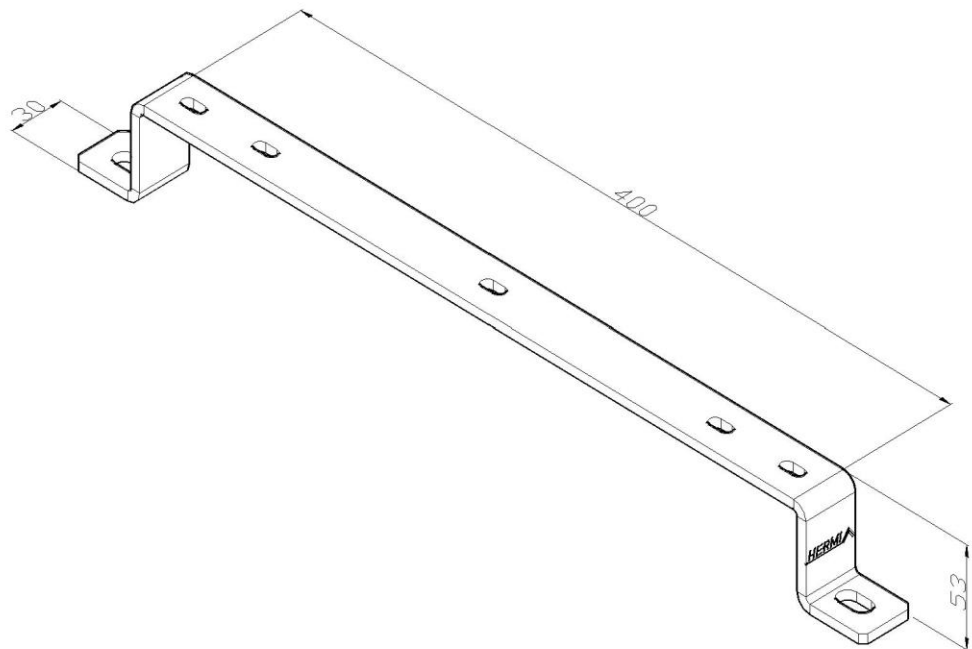

Standard:	EN 61537:2007 Cable management - Cable tray systems and cable ladder systems
Dimensions:	Length: 400 mm
	Width: 30 mm
	Height: 53 mm
	Metal thickness: 5 mm
Maximum load:	
Weight:	0,67 kg
Material:	Hot-dip galvanised steel
Contribution to fire:	Non-flame propagating system
Electrical characteristics:	Electrically conductive system
Electrical continuity:	Yes
Corrosion resistance:	Class 6
Temperature:	Min: -20°C; Max: +105°C