

Product: NKP-SNL 210

Product code: 88704302

Wall bracket

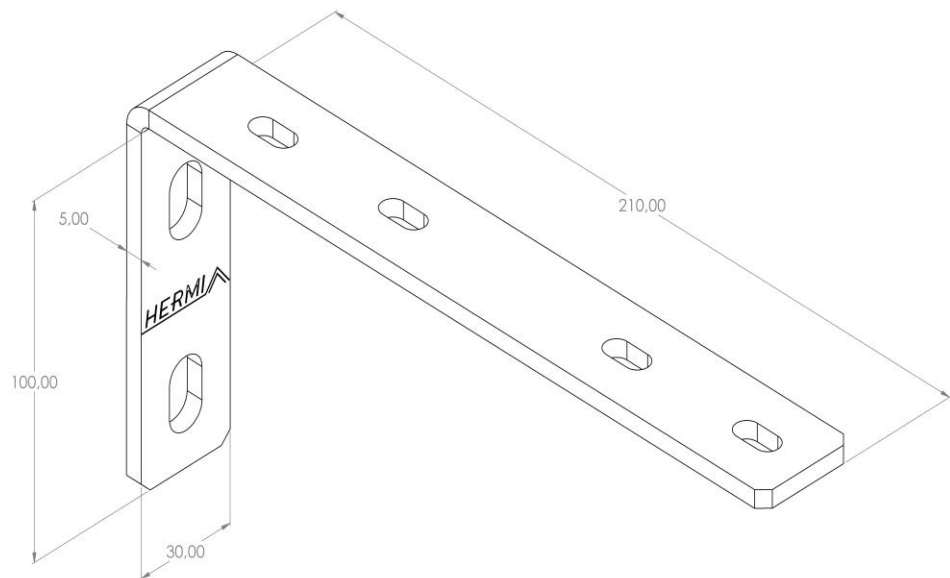

Standard:	EN 61537:2007 Cable management - Cable tray systems and cable ladder systems
Dimensions:	Length: 210 mm
	Width: 30 mm
	Height: 100 mm
	Metal thickness: 5 mm
Maximum load:	0,4 kN
Weight:	0,36 kg
Material:	Powder coated galvanised steel in the colours according to the RAL scale
Contribution to fire:	Non-flame propagating system
Electrical characteristics:	Electrically conductive system
Electrical continuity:	Yes
Corrosion resistance:	Class 3
Temperature:	Min: -20°C; Max: +105°C