

Product: NKP-VNV 1500

Product code: 88704223

Welded hanging bracket

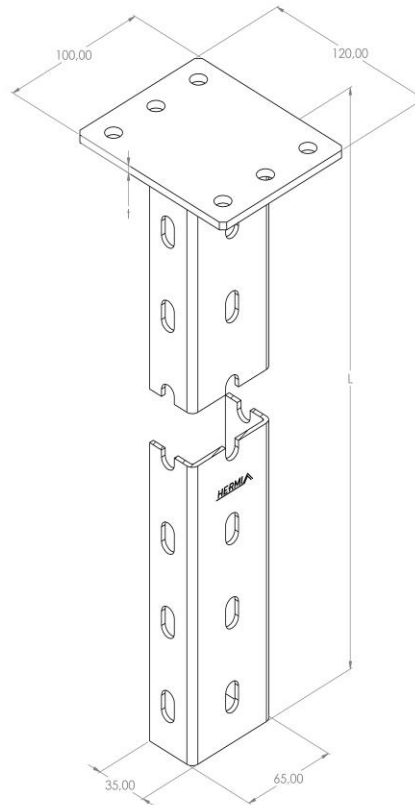

Standard:	EN 61537:2007 Cable management - Cable tray systems and cable ladder systems
Dimensions:	Length: 100 mm
	Width: 120 mm
	Height: 1500 mm
	Metal thickness: 5 mm
Maximum bending moment:	1,85 kNm
Weight:	4,4 kg
Material:	Stainless steel
Contribution to fire:	Non-flame propagating system
Electrical characteristics:	Electrically conductive system
Electrical continuity:	Yes
Corrosion resistance:	Class 9A
Temperature:	Min: -20°C; Max: +105°C