

**Product:** NKP-SNV 110

**Product code:** 88704204

Welded wall bracket

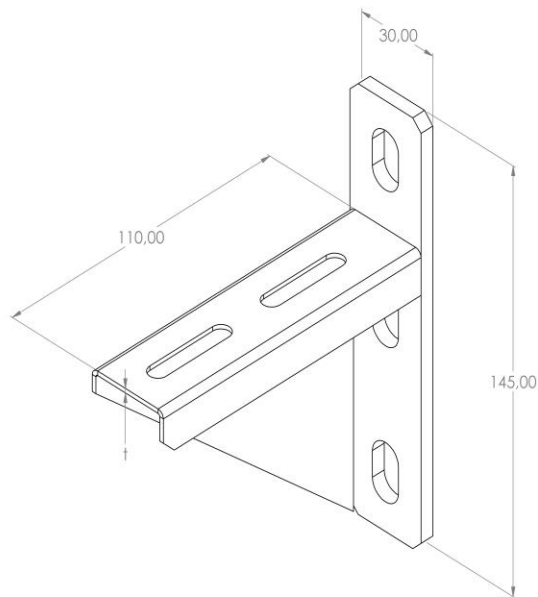

<b>Standard:</b>	EN 61537:2007 Cable management - Cable tray systems and cable ladder systems
<b>Dimensions:</b>	Length: 110 mm
	Width: 30 mm
	Height: 145 mm
	Metal thickness: 3 mm
<b>Maximum load:</b>	2,4 kN
<b>Weight:</b>	0,25 kg
<b>Material:</b>	Stainless steel
<b>Contribution to fire:</b>	Non-flame propagating system
<b>Electrical characteristics:</b>	Electrically conductive system
<b>Electrical continuity:</b>	Yes
<b>Corrosion resistance:</b>	Class 9A
<b>Temperature:</b>	Min: -20°C; Max: +105°C