

Product: NKP-SNV 510

Product code: 88704108

Welded wall bracket

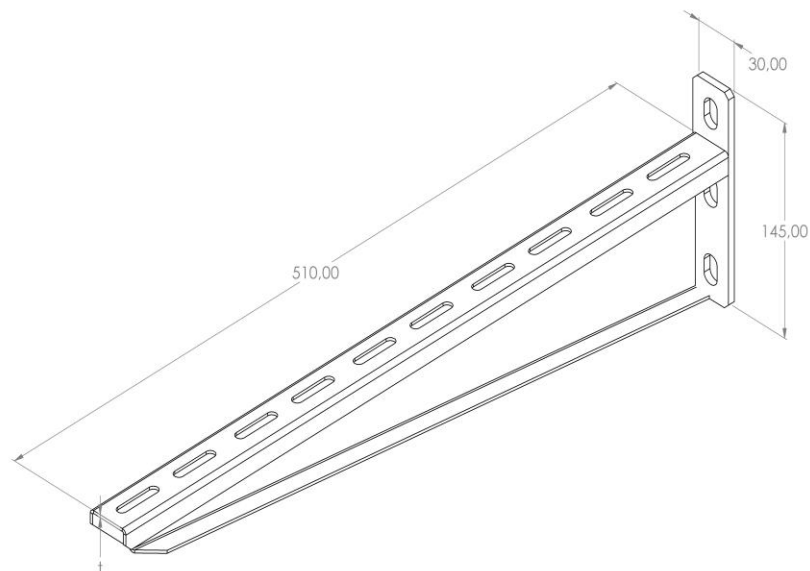

Standard:	EN 61537:2007 Cable management - Cable tray systems and cable ladder systems
Dimensions:	Length: 510 mm
	Width: 30 mm
	Height: 145 mm
	Metal thickness: 3 mm
Maximum load:	3,75 kN
Weight:	1,2 kg
Material:	Galvanised steel
Contribution to fire:	Non-flame propagating system
Electrical characteristics:	Electrically conductive system
Electrical continuity:	Yes
Corrosion resistance:	Class 3
Temperature:	Min: -20°C; Max: +105°C