

Product: PKP-PEK 60/800

Product code: 88702508

Element for attaching electrical cables in cable trays

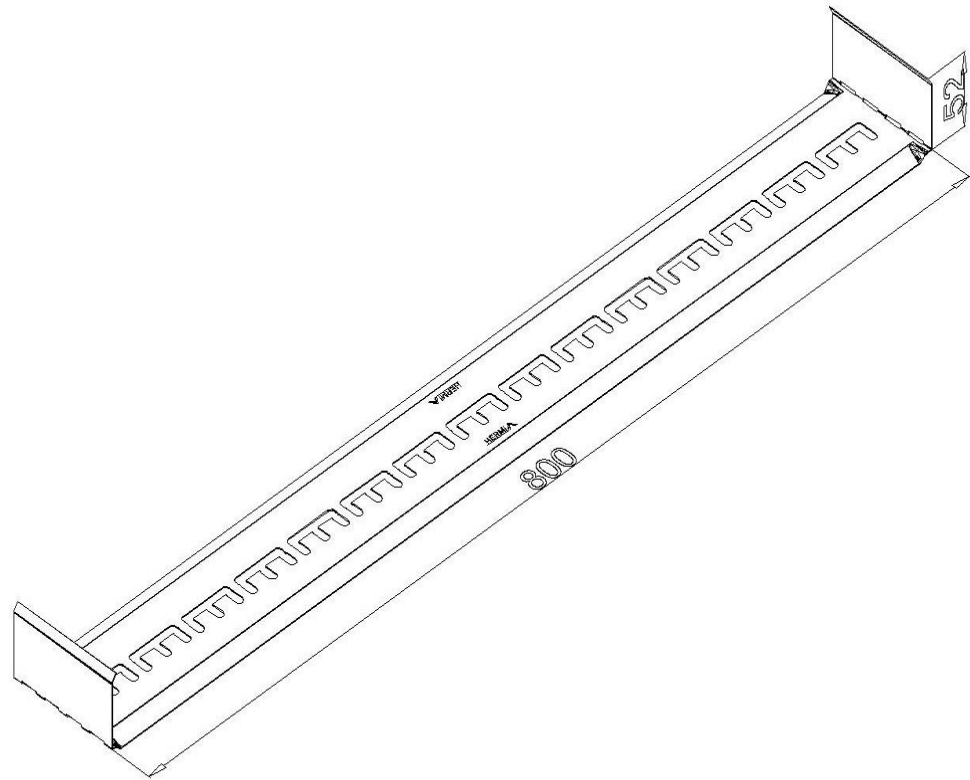

Standard:	EN 61537:2007 Cable management - Cable tray systems and cable ladder systems
Dimensions:	Length: 800 mm
	Width: 100 mm
	Height: 52 mm
	Metal thickness: 0,80 mm
Weight:	0,56 kg
Material:	Stainless steel
Contribution to fire:	Non-flame propagating system
Electrical characteristics:	Electrically conductive system
Electrical continuity:	Yes
Corrosion resistance:	Class 9A
Temperature:	Min: -20°C; Max: +105°C