

Product: PKP-OEP 400

Product code: 88701424

Add-on tee cover

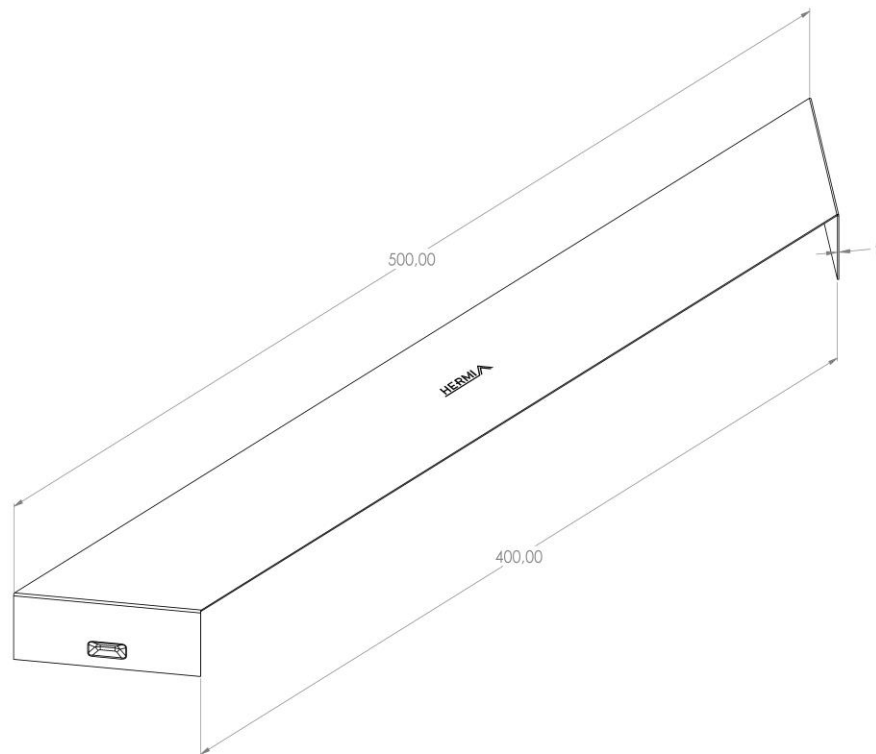

Standard:	EN 61537:2007 Cable management - Cable tray systems and cable ladder systems
Dimensions:	Length: mm
	Width: 400/500 mm
	Height: 16 mm
	Metal thickness: 1,50 mm
Weight:	
Material:	Galvanised steel
Contribution to fire:	Non-flame propagating system
Electrical characteristics:	Electrically conductive system
Electrical continuity:	Yes
Corrosion resistance:	Class 3
Temperature:	Min: -20°C; Max: +105°C