

Product: PKP-REDP 600/500

Product code: 88701245

Right reduction element cover

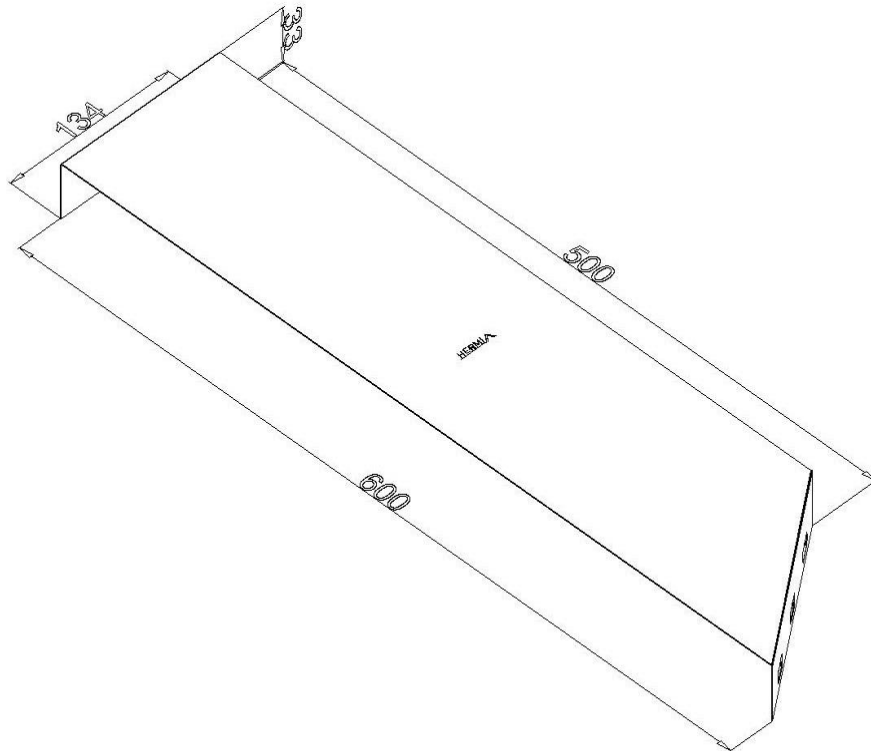

Standard:	EN 61537:2007 Cable management - Cable tray systems and cable ladder systems
Dimensions:	Length: 134 mm
	Width: Reduced width 600/500 mm
	Height: 33 mm
	Metal thickness: 0,60 mm
Weight:	0,4 kg
Material:	Galvanised steel
Contribution to fire:	Non-flame propagating system
Electrical characteristics:	Electrically conductive system
Electrical continuity:	Yes
Corrosion resistance:	Class 3
Temperature:	Min: -20°C; Max: +105°C