

Product: PKP-ZKP 50

Product code: 88701217

External elbow cover 90°

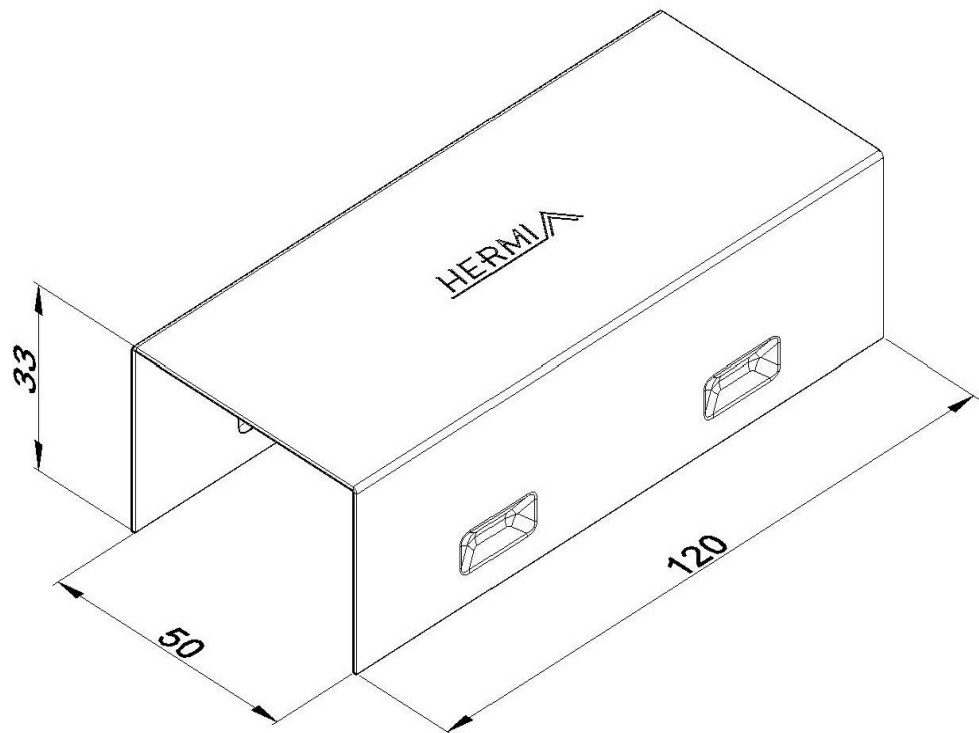

Standard:	EN 61537:2007 Cable management - Cable tray systems and cable ladder systems
Dimensions:	Length: 120 mm
	Width: 50 mm
	Height: 33 mm
	Metal thickness: 0,60 mm
Weight:	0,07 kg
Material:	Galvanised steel
Contribution to fire:	Non-flame propagating system
Electrical characteristics:	Electrically conductive system
Electrical continuity:	Yes
Corrosion resistance:	Class 3
Temperature:	Min: -20°C; Max: +105°C